

Panorama

Fabrice Berrux



The Panorama collection of padded products is based on a specific item which can be considered to be the real unit of measurement of the system: the hexagonal pouf which, when fitted with armrests and a backrest, becomes an armchair which, in turn, can be combined with additional armchairs and sofas to achieve the most diverse configurations. Customisation and creativity reach their utmost expression here, and the results that can be achieved are absolutely unprecedented.

UPHOLSTERY:

fabric

Capri leather

Ischia leather

Procida leather

Ponza Nabuk leather

Ponza Anilina leather

FEET:

anthracite grey painted wood

Divano - Sofa 260

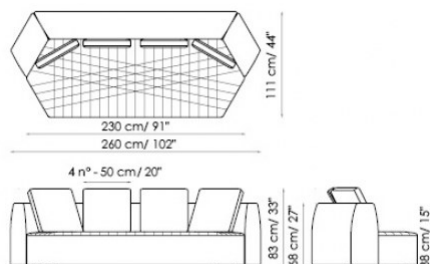

Divano - Sofa 230

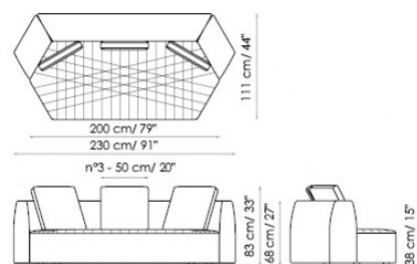

Divano - Sofa 200

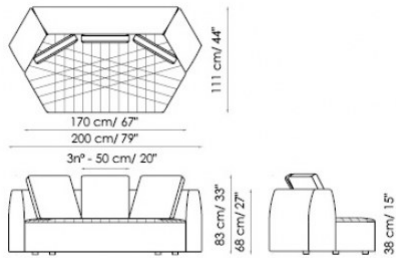

Terminale dx o sx - End section Sofa right or left

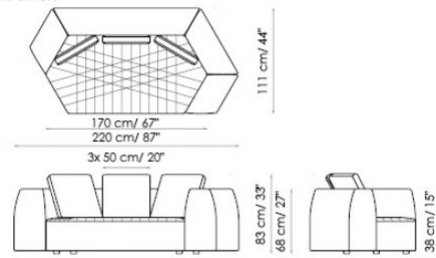

Laterale - Side element 223 dx - right

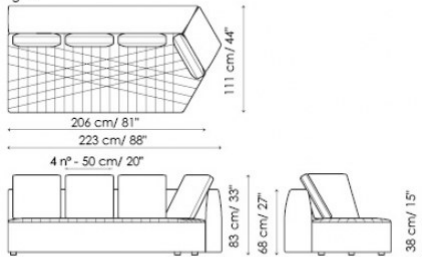

Laterale - Side element 193 dx - right

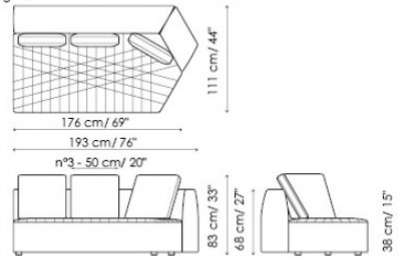

Chaise longue dx - right

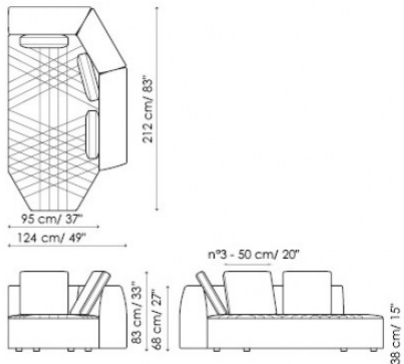

Dormeuse

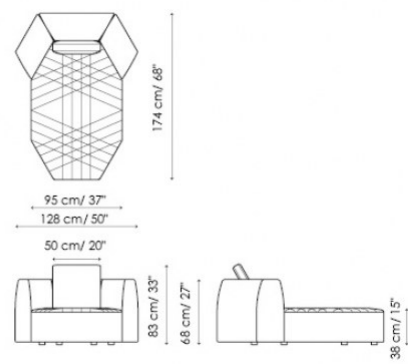

Poltrona - armchair

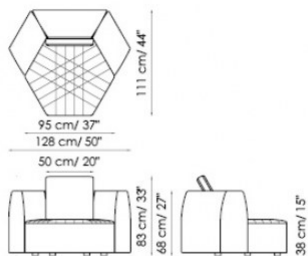

Poltrona con bracciolo - armchair with armrest dx - right

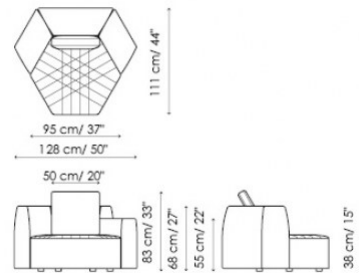

Poltrona large - large armchair

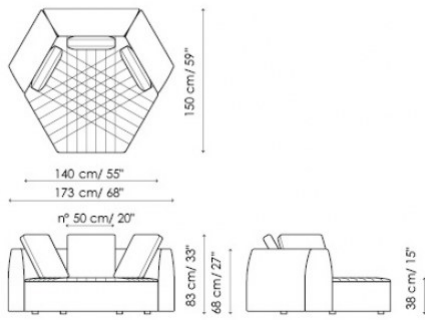

Pouf

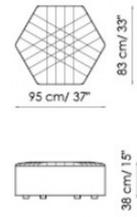

Pouf con ruote - with castors

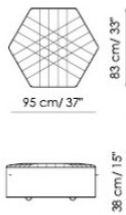

Cuscino - Cushion

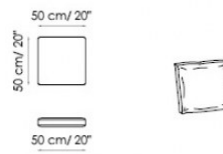

Cuscino ego - Cushion ego

